



**Advanced Heating
& Hot Water Systems**

MUNCHKIN

STAINLESS STEEL HIGH EFFICIENCY BOILER

This is one of the most compact and efficient heaters available on the market today. Each Munchkin Boiler will modulate its firing rate to match the actual energy requirements. This feature provides additional savings versus traditional single firing heaters. With stainless steel construction, you can be assured that you are buying the highest quality appliance. Proven European technology, manufactured in the United States. Quiet operation is just another benefit that comes with the Munchkin Boiler.



Durability • High Efficiency • Reliability • Quiet Operation

The Munchkin Gas Boiler:

The Most Compact and Efficient Boiler Available on the Market

How it Operates

When the room thermostat calls for heat, the Munchkin control board will start the pump and start to monitor the return water temperature of the system before the heater will begin to heat the water. Once the controller has sensed a drop in the return water temperature below the temperature set point minus the differential set point, the boiler will start to heat the water. This eliminates the boiler starting every time the thermostat calls for heat. This feature keeps the system from short cycling.

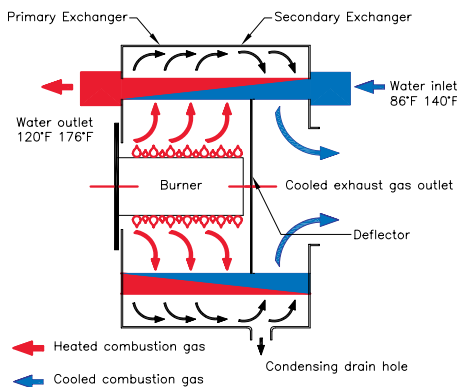

Once the system has sensed the temperature difference, the Munchkin will activate the blower motor for 5 seconds to prepurge the system before starting the Munchkin. The Munchkin Controller will now start to modulate the pre-mix burner based on analyzing the return water temperature, supply water temperature, and the set point temperature. By compiling this infor-

mation, the controller utilizes an algorithm to fully adjust the firing rate while maintaining the desired output temperature. The pre-mix burner fans have a low-voltage direct current drive motor with a pulse relay counting. This system allows precise control over the fan speed and combustion air volumes. Coupled with the gas valve and the swirl plate system set to provide a one-to-one ratio of precisely measured volumes of fuel to air, accurate and instant burner output is achieved. This keeps the Munchkin running at the highest efficiency 90% AFUE.

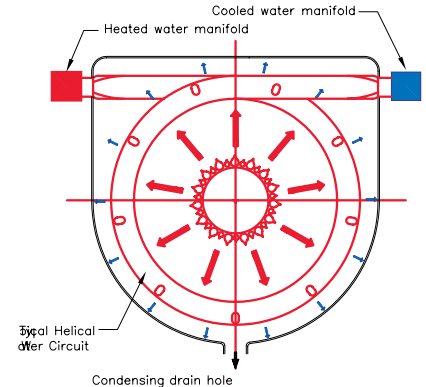

When the thermostat is satisfied, the Munchkin will then go through a 4 second post-purge cycle before shutting off. Munchkins are equipped with a control display with indicators that show the normal operation of the boiler. This display will also serve as a diagnostic tool for servicing.

■ 90% AFUE condensing technology

The cost of fuel in some areas of the country has increased almost 40% in just one year! Munchkin High Efficiency Modulating 90% AFUE Gas Boilers provides a maximum payback on fuel savings. As the chart illustrates below savings can result in payback periods of less than 3 years. Depending on the age of your present equipment, the Munchkin could save you as much as 50% on your fuel bills.

3-Year Energy Costs

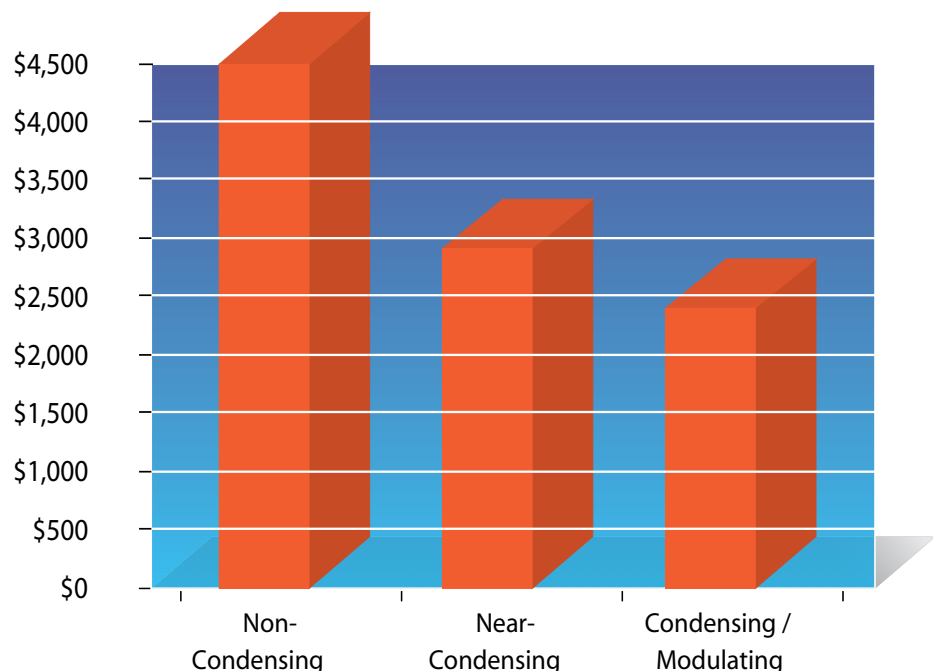

■ Durable All Stainless Steel Heat Exchanger

The Munchkin Design starts with the individual stainless steel helical water circuits, which provide maximum corrosion resistance caused by the condensing of the flue gas inside the secondary portion of the heat exchanger. The flue and



individual stainless steel water circuits are baffled to direct the flow which maximize the heat

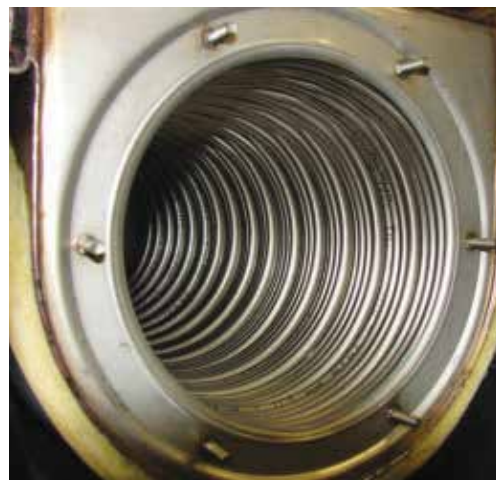

transfer rate. This allows the heat energy from the combustion process to transfer directly into the water as it passes through the individual stainless steel helical circuits. The Munchkin Heat Exchanger absorbs so much energy that the exhaust gas can be vented with standard schedule 40 PVC pipe. The sealed combustion process and minimal water volume content eliminates external heat loss, this means very little stand by heat loss, resulting in additional energy savings versus a traditional system.

Features and Benefits

■ Fully Modulating for Ultra High Efficiency (90% AFUE)

Lowest possible operating cost. Rapid return on investment.

■ Consists of 316L Stainless Steel Construction

Highest quality material available for maximum reliability.

■ Compact, Lightweight Design

Installs virtually anywhere, where similar appliances cannot! Zero clearance to combustibles and a small footprint. Its lightweight design makes it easy to be installed by one person! The Munchkin can even be shipped via Parcel Service!

■ Add-On Vision Systems

The Vision Systems offer the customer Outdoor Reset, and Indirect Priority.

■ Direct Vent with Standard Schedule 40 PVC Plastic Pipe

Less expensive to install. No chimney required! Installation flexibility.

■ Quiet Operation

Refrigerator quiet!

■ State-of-the-Art Control

Self-diagnostic microprocessor control system to simplify service.

■ Reliable Field-proven Spark Ignition

Constant dependable operation

■ Each Unit is Inspected for 100% Quality Satisfaction

Superior quality

■ Sealed Combustion

Safest-operating appliance available

■ Environmentally Friendly

Low emissions environment

■ Modular Component Construction

Easily maintained.

■ 12 Year Limited Warranty

Assurance of quality.

■ Operates at Low Supply Temperature

No bypass valve controls needed to protect boiler.

■ New: 1 1/4" NPT Return and Supply Connections

Standard Equipment

- Plastic Boiler Jacket
- Modulating Boiler Controller
- Burner Fan
- Dungs Gas Valve
- 24 Volt Transformer
- Supply / Return Temperature Thermister
- Water Pressure Switch (Set at 8 PSI)
- Wiring Harness
- 5/8 Condensation Connection
- Spark Electrode
- Vent Termination Coupling and Tee (PVC)
- Rectification Probe
- High Grade Inconel "NIT" Burner
- Electrical Junction Box With Switch
- High Limit Temperature Control
- 30 PSI ASME Relief Valve
- Combination Pressure - Temperature Gauge
- New 1 1/4" Boiler Return & Supply Connections

Design Enhancements



A unique, high grade Inconel "NIT" burner, with reliable spark ignition, coupled with the Dungs gas valve and the swirl plate system. This pre-mix combustion system is the engine that provides reliable and efficient operation.



↑ The patented Munchkin Heat Exchanger has been designed to provide maximum heat transfer, while also providing unsurpassed corrosion resistance with stainless steel construction.



← The Munchkin 925 Control Board is engineered to modulate the firing rate to match the actual needs of the heat system, saving money by conserving energy.

Optional Equipment

- SuperStor Ultra Indirect Fired Water Heater
- SuperStor Ultra Pool Heater
- Condensate Neutralizer Kit
- Vent Kit Includes:
 - ◆ V1000 Aluminum Outside Termination Kit
 - ◆ Concentric Vent Kit Termination 3"

Performance Ratings

Model	Input Modulation	DOE Heating	AFUE	Shipping Weight	IBR
T50	18,000 to 50,000	16,000 to 46,000	90%	58 lbs.	40,000
T80	19,000 to 80,000	17,000 to 74,000	90%	58 lbs.	64,000
80M	27,000 to 80,000	25,000 to 74,000	90%	75 lbs.	64,000
140M	46,000 to 140,000	43,000 to 129,000	90%	101 lbs.	112,000
199M	66,000 to 199,000	61,000 to 183,000	90%	111 lbs.	159,000

Recommended Service Clearances

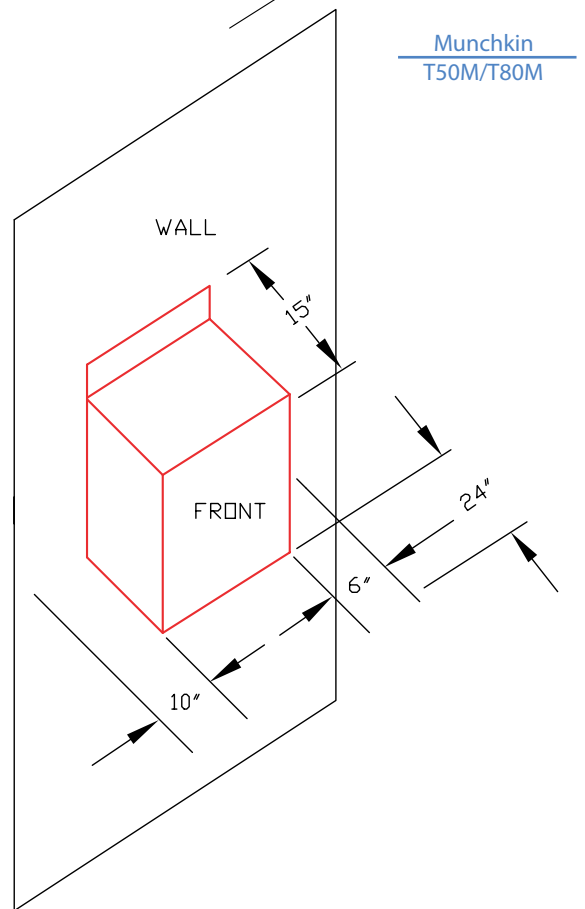
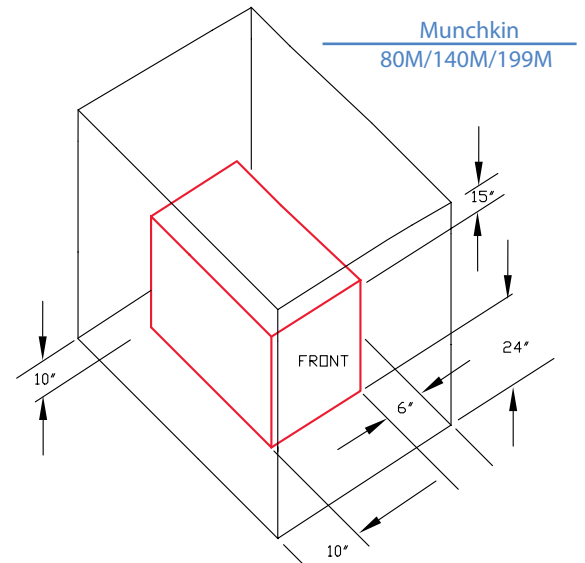

Connection Sizes

Model	Supply/Return Connection	Gas Connection Size	Vent Diameter
T50	1-1/4" NPT	3/4"	2"
T80	1-1/4" NPT	3/4"	2"
80M	1-1/4" NPT	3/4"	3"
140M	1-1/4" NPT	3/4"	3"
199M	1-1/4" NPT	3/4"	3"

The Munchkin Gas Boiler — Ideal for Home Use



Dimensions

T50 / T80M

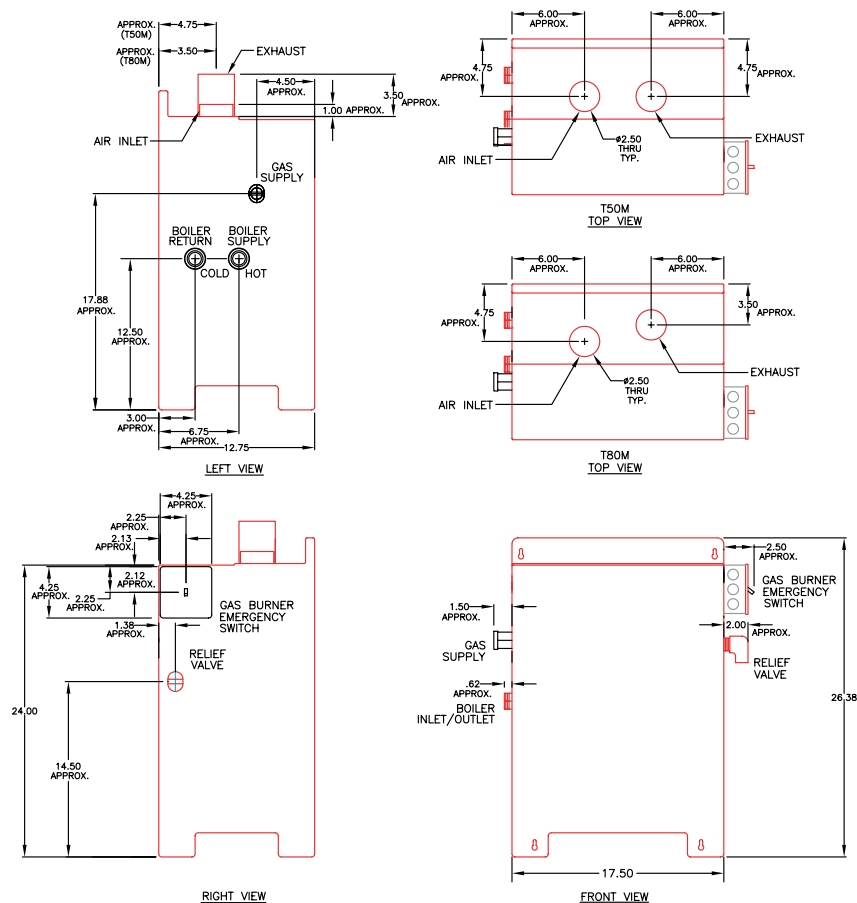

Dimensions

80M

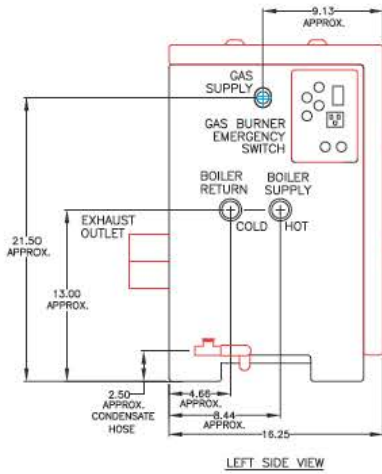

LEFT SIDE VIEW

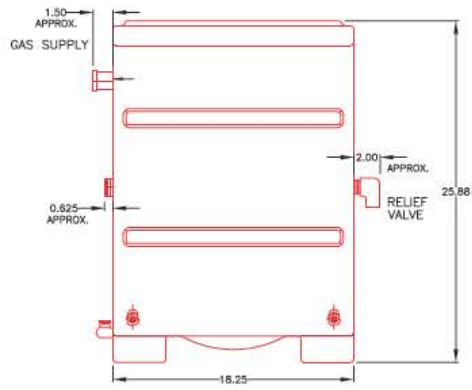

FRONT VIEW

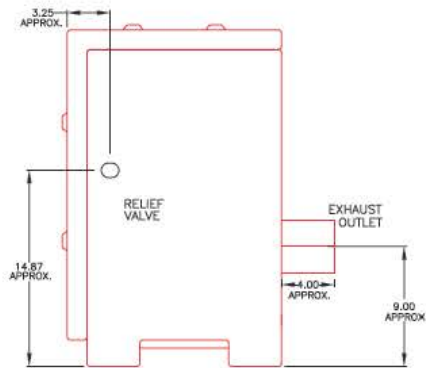

RIGHT SIDE VIEW

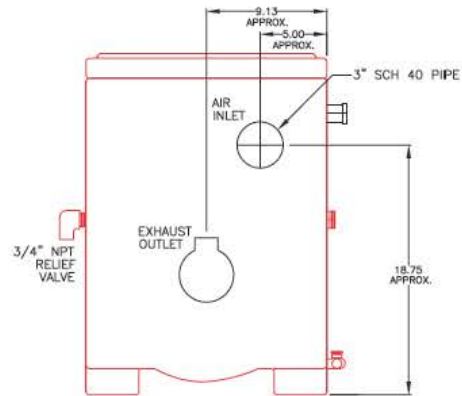

BACK VIEW

140M / 199M

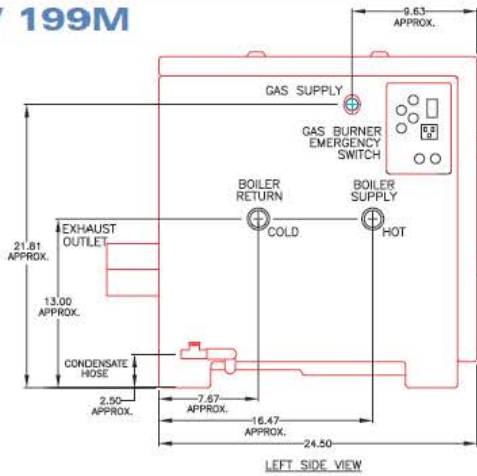

LEFT SIDE VIEW

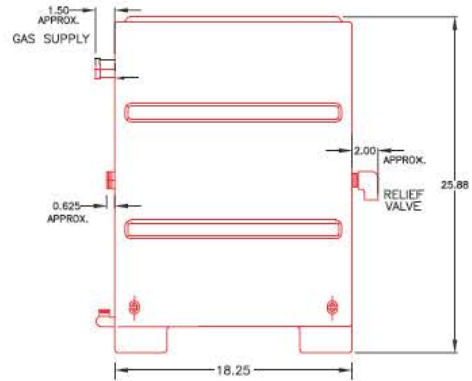

FRONT VIEW

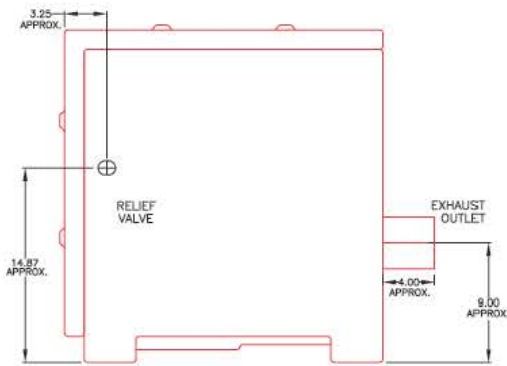

RIGHT SIDE VIEW

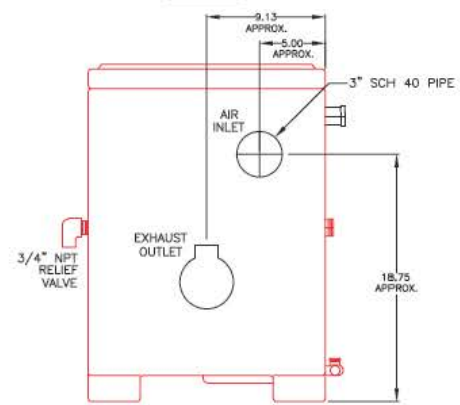

BACK VIEW