

# Quick Start Guide

## Models: 3kW / 6.5kW / 10.5kW / 13kW

### Step 1 - Before Installing

#### WARNING

This Quick Start Guide DOES NOT replace the Use and Care Manual. Read and comprehend the Use and Care Manual before installing this product.

This product must only be installed by a qualified installer / service technician.

The manufacturer will not be held liable for any damages resulting from improper installation.

When applicable, the installation must conform with Manufactured Home Construction and Safety Standards, Title 24 CFR, Part 3280 and/or CAN/CSA Z240 MH Series Mobile Homes.

Follow all local codes as well as the most recent edition of the latest version of the National Electrical Code, NFPA No. 70.

Failure to follow these instructions before installation could result in property damage, personal injury or death.

### Step 2 - Installing

#### A. Unpacking

#### NOTICE

Any claims for damage or shortage in shipment must be filed immediately against the transportation company by the consignee.

#### B. Location Requirements

Choose a location for the water heater as centralized to the piping and electrical system as possible, and where domestic water piping will not be exposed to freezing temperatures. All piping should be insulated. Additionally, place the water heater so that the drain, controls, and inlets/outlets are easily accessible.

#### C. Wall Mounting

The mounting surface must be solid and secure. Do not install the unit above electrical boxes or junctions. Ensure the unit is level. Mount the unit to the wall with four (4) screws of at least one (1) inch in length.

#### NOTICE

Use screws suitable for the wall material and the weight of the water heater. Failure to do so could result in property damages and damage to the water heater. Such damages ARE NOT covered by product warranty.

The appliance must be mounted horizontally, with water inlets and outlets at the bottom. See Figure 1.

#### WARNING

This water heater must be installed upright in the vertical position as described in this manual. DO NOT attempt to install this water heater in any other orientation. Doing so will result in improper water heater operation and property damage, and could result in serious personal injury or death.

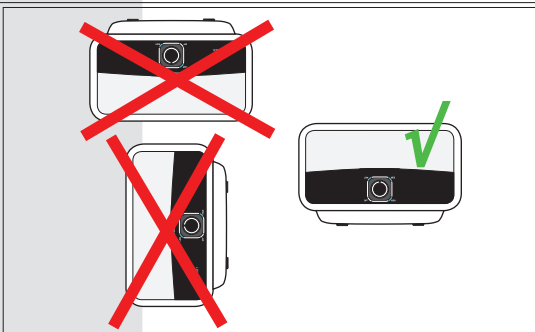

Figure 1 - DO NOT INSTALL THE WATER HEATER UPSIDE DOWN

### Step 3 - Plumbing

It is mandatory that all plumbing be done in accordance with federal, local, and state plumbing codes and practices.

The supplied pressure relief device (PRD) must be installed to protect against excessive pressures.

**NOTE:** It is highly recommended by the manufacturer to install water leak detection devices and automatic shutoff valves in any water heater installation where a leakage of water could result in property damages.

Connect the water inlet line to the entry point of the heater (left side inlet), and connect the outlet line to the water outlet. Use a line that can withstand a minimum pressure of 58 psi. Using any other type of line will cause damage.

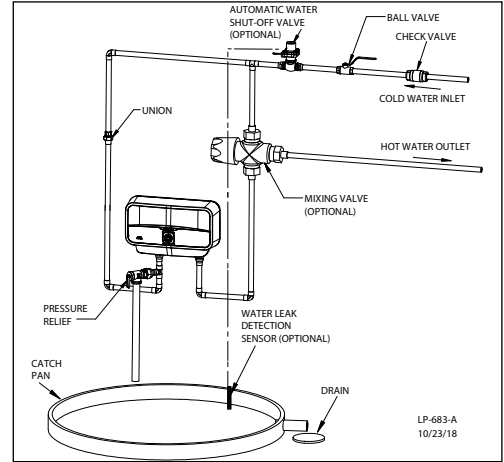

Figure 2 - General Piping Detail

### Step 4 - Electrical Connection

The voltage requirement and dedicated wattage load for the heater is specified on the water heater rating label. Consult your local power company to determine if your electrical service is adequate for the additional load of the heater. Make secure, appropriate wiring connections to the water heater per the National Electric Code.

*Wattage (kW)	Voltage	Amperage	Phase	Circuit Breaker Size	Required Wire Size
3	120	25	1	1 x 30	10 AWG
6.5	240	27		1 x 30	
8.5		36		1 x 40	6 AWG
10.5		44		1 x 50	
13		54		1 x 60	4 AWG

Table 1 - Technical Specifications - \*Wattage based on maximum voltage.

























**NOTE:** On 3kW models, a 0.5 GPM flow restrictor is recommended for optimal operation.

**NOTE:** On 6.5, 8.5, 10.5, and 13kW models, no wires are included for external wiring. All external wiring is to be field supplied.

### Fixture Flow Rates

Shower 1.5 GPM (Range 1.5-2.5)  Sink .5 GPM (Range .5-1.5) 

- Max Flow Rate Calculated for 105°F Outlet Water Temperature  
 - Standard Install is 240V, if 208V is used Increase One Model Size from the Chart Below

Inlet Temp.	Single & Multipoint 			
	110-120V 3.1-3.5 KW	240V 6.5 KW	240V 10.5 KW	240V 13 KW
<b>40°F</b> Max Flow Rate			 	 
		.7 GPM	1.1 GPM	1.4 GPM
<b>50°F</b> Max Flow Rate			 	
	.5 GPM	.8 GPM	1.3 GPM	1.6 GPM
<b>60°F</b> Max Flow Rate		 		 
	.5 GPM	1 GPM	1.6 GPM	2 GPM
<b>70°F</b> Max Flow Rate		 	 	  
	.6 GPM	1.3 GPM	2 GPM	2.5 GPM

# Quick Start Guide

## Models: 18kW / 24kW / 27kW / 36kW

### Step 1 - Before Installing

#### WARNING

This Quick Start Guide DOES NOT replace the Use and Care Manual. Read and comprehend the Use and Care Manual before installing this product.

This product must only be installed by a qualified installer / service technician.

The manufacturer will not be held liable for any damages resulting from improper installation.

When applicable, the installation must conform with Manufactured Home Construction and Safety Standards, Title 24 CFR, Part 3280 and/or CAN/CSA Z240 MH Series Mobile Homes.

Follow all local codes as well as the most recent edition of the latest version of the *National Electrical Code, NFPA No. 70*.

Failure to follow these instructions before installation could result in property damage, personal injury or death.

### Step 2 - Installing

#### A. Unpacking

#### NOTICE

Any claims for damage or shortage in shipment must be filed immediately against the transportation company by the consignee.

#### B. Location Requirements

Choose a location for the water heater as centralized to the piping and electrical system as possible, and where domestic water piping will not be exposed to freezing temperatures. All piping should be insulated. Additionally, place the water heater so that the drain, controls, and inlets/outlets are easily accessible.

#### C. Wall Mounting

The mounting surface must be solid and secure. Do not install the unit above electrical boxes or junctions. Ensure the unit is level. Mount the unit to the wall with four (4) screws of at least one (1) inch in length.

#### NOTICE

Use screws suitable for the wall material and the weight of the water heater. Failure to do so could result in property damages and damage to the water heater. Such damages ARE NOT covered by product warranty.

The appliance must be mounted horizontally, with water inlets and outlets at the bottom. See Figure 3.

#### WARNING

This water heater must be installed upright in the vertical position as described in this manual. DO NOT attempt to install this water heater in any other orientation. Doing so will result in improper water heater operation and property damage, and could result in serious personal injury or death.

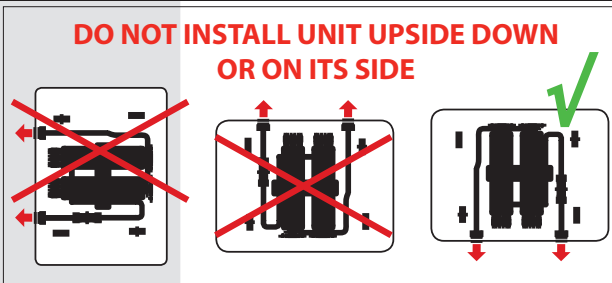

Figure 3 - DO NOT INSTALL THE WATER HEATER UPSIDE DOWN

### Step 3 - Plumbing

It is mandatory that all plumbing be done in accordance with federal, local, and state plumbing codes and practices.

A temperature and pressure relief valve (T&P) is not required for most installations, as UL Standard 499 does NOT require that a pressure relief valve be used. However, a T&P valve may be required to meet installation codes in your area.

**NOTE:** It is highly recommended by the manufacturer to install water leak detection devices and automatic shutoff valves in any water heater installation where a leakage of water could result in property damages.

Connect the water inlet line to the entry point of the heater (right side inlet), and connect the outlet line to the water outlet. Use a line that can withstand pressure up to 145 psi. Using any other type of line will cause damage. Install unions on the hot and cold water connections to easily disconnect the water heater for servicing.

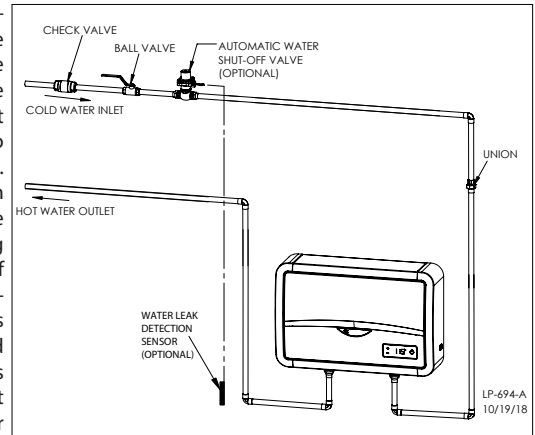

Figure 4 - General Piping Detail

### Step 4 - Electrical Connection

The voltage requirement and dedicated wattage load for the heater is specified on the water heater rating label. Consult your local power company to determine if your electrical service is adequate for the additional load of the heater. For power supply connection use 8/2 AWG wires or larger, suitable for at least 194°F (90°C).

Make secure, appropriate wiring connections to the water heater per the National Electric Code.

Model	*Wattage (kW)	Max Amperage	Required Breaker(s)	Required Wire Size
18kW	18	75	3 x 30A Double Pole	3 x 10 AWG w/ Ground
24kW	24	100	3 x 40A Double Pole	3 x 8 AWG w/ Ground
27kW	27	112.5		
36kW	36	150	4 x 40A Double Pole	4 x 8 AWG w/ Ground

Table 2 - Technical Specifications - \*Wattage based on maximum voltage.

### Fixture Flow Rates

Shower 1.5 GPM (Range 1.5-2.5)  Sink .5 GPM (Range .5-1.5) 

- Max Flow Rate Calculated for 105°F Outlet Water Temperature  
 - Standard Install is 240V, if 208V is used Increase One Model Size from the Chart Below

Inlet Temp.	Whole Home 			
	240V 18KW	240V 24 KW	240V 27 KW	240V 36 KW
40°F Max Flow Rate	 1.9 GPM	 2.5 GPM	 2.8 GPM	 3.8 GPM
50°F Max Flow Rate	 2.2 GPM	 2.9 GPM	 3.4 GPM	 4.5 GPM
60°F Max Flow Rate	 2.7 GPM	 3.6 GPM	 4 GPM	 5.5 GPM
70°F Max Flow Rate	 3.5 GPM	 4.6 GPM	 5.3 GPM	 7 GPM